

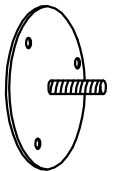









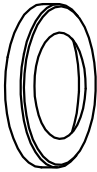
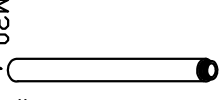
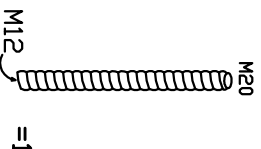



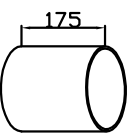

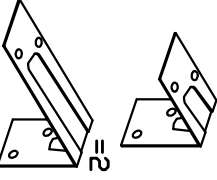

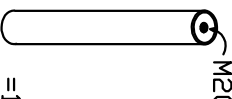
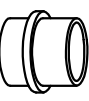
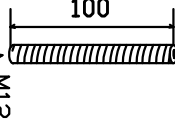

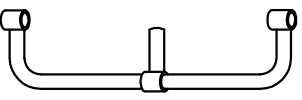

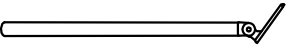
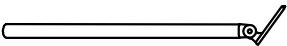

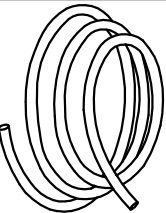

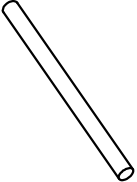
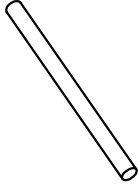
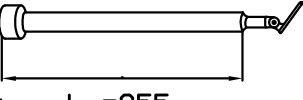
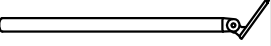



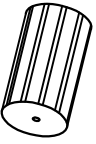

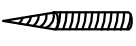

<p>A1</p>  <p>=1</p>	<p>A2</p> <p>12 mm</p>  <p>Ø12</p> <p>=3</p>	<p>A3</p>  <p>Ø8x80</p> <p>=3</p>	<p>A4</p>  <p>=1</p>	<p>A5</p>  <p>M20</p> <p>=1</p>	<p>A6</p>  <p>M20</p> <p>M12</p> <p>=1</p>	<p>A7</p>  <p>=1</p>	<p>A8</p>  <p>A20</p> <p>=1</p>	<p>A9</p>  <p>M20</p> <p>=2</p>
<p>A10</p>  <p>175</p> <p>D120= Ø100 D140= Ø100 D160= Ø114</p> <p>=13</p>	<p>A11</p>  <p>D120= Ø100 D140= Ø100 D160= Ø114</p> <p>=78</p>	<p>A12</p>  <p>=2</p>	<p>A13</p>  <p>5x25</p> <p>=12</p>	<p>A14</p>  <p>Ø6x80</p> <p>=8</p>	<p>A16</p>  <p>M20</p> <p>=1</p>	<p>A17</p>  <p>=8</p>	<p>A18</p>  <p>M12</p> <p>100</p> <p>M12</p> <p>=1</p>	<p>A19</p>  <p>=2</p>
<p>B1</p>  <p>=1</p>	<p>B2</p>  <p>4,2x13mm</p> <p>=7</p>	<p>B3</p> <p>1155 mm</p>  <p>=13</p>	<p>B4</p> <p>1010 mm</p>  <p>=12</p>	<p>B5</p> <p>10 mm</p>  <p>Ø10</p> <p>=12</p>	<p>B6</p>  <p>4X16</p> <p>=66</p>	<p>B7</p>  <p>=1</p>	<p>B8</p>  <p>=4</p>	<p>B9</p>  <p>=1</p>
<p>B10</p>  <p>=1</p>	<p>B11</p>  <p>955</p> <p>=1</p>	<p>B12</p> <p>955 mm</p>  <p>D120 D140 D160</p> <p>=5 =6 =7</p>	<p>B13</p>  <p>5x50</p> <p>=2</p>	<p>B14</p>  <p>=2</p>	<p>B15</p>  <p>=1</p>	<p>B16</p>  <p>M8x60</p> <p>=4</p>	<p>B17</p>  <p>=2</p>	

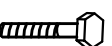

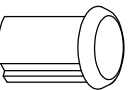



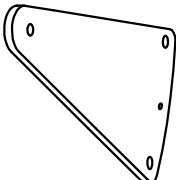
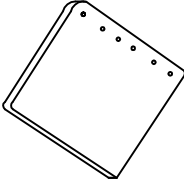
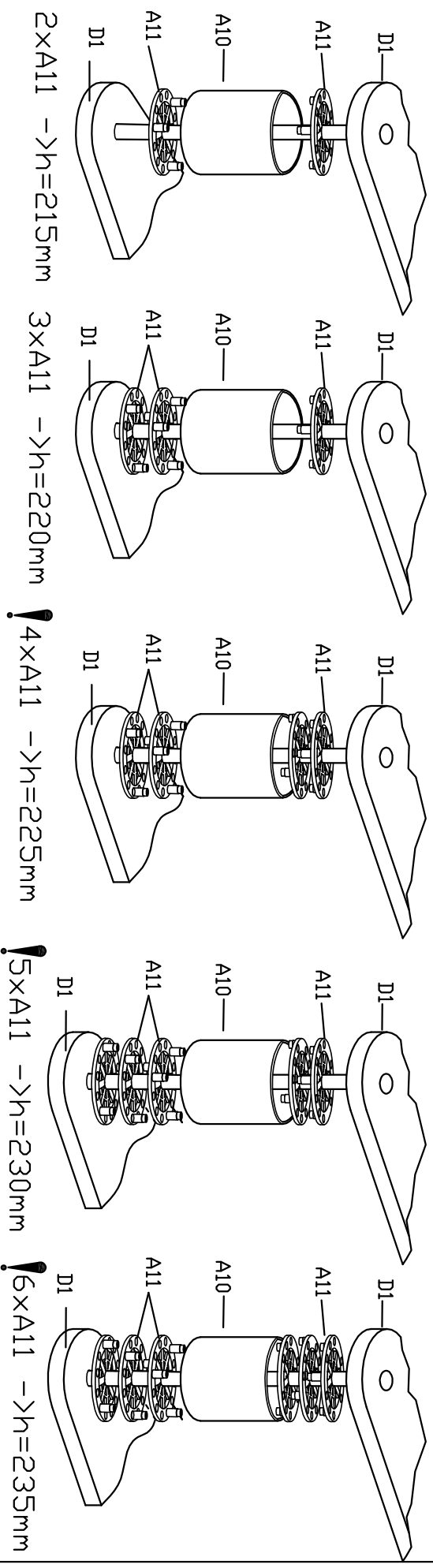

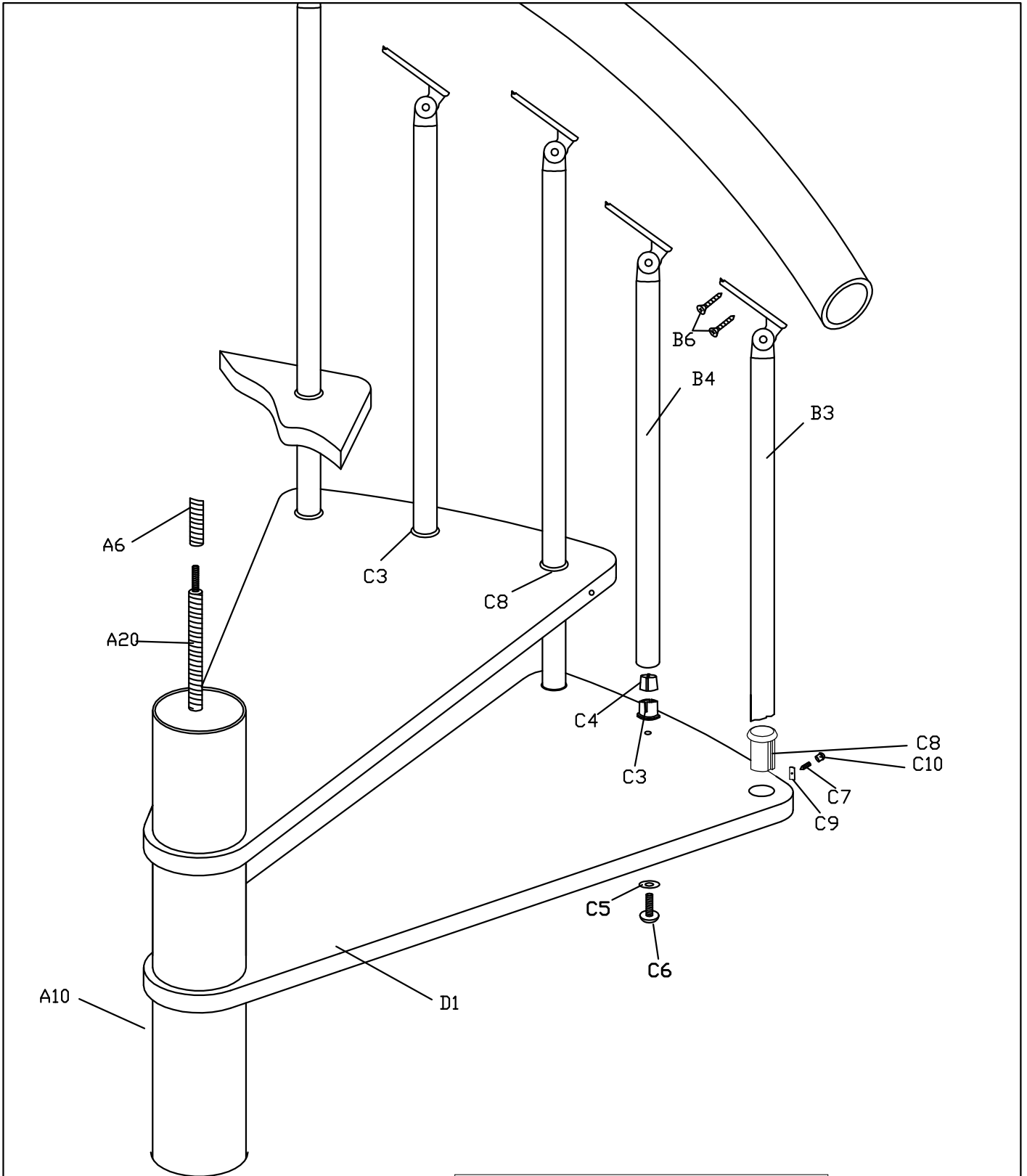

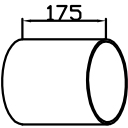
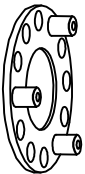

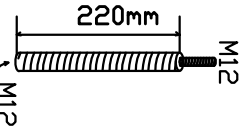
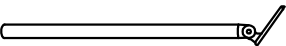
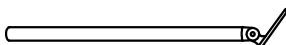
BARI - D 120/140/160

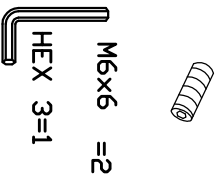
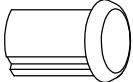
C1	 12 mm Ø12 =1	C2	 M8x80 =1	C3	 =20	C4	 =20	C5	 8 mm A8x24 =19	C6	 M8x60mm =19	C7	 M6x6 =25 HEX 3=1	C8	 =25	C9	 =25
C10	 =25	C11	 =12									D1	 =12	D2	 =1		



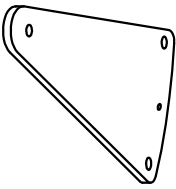



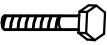

BARI - D 120/140/160

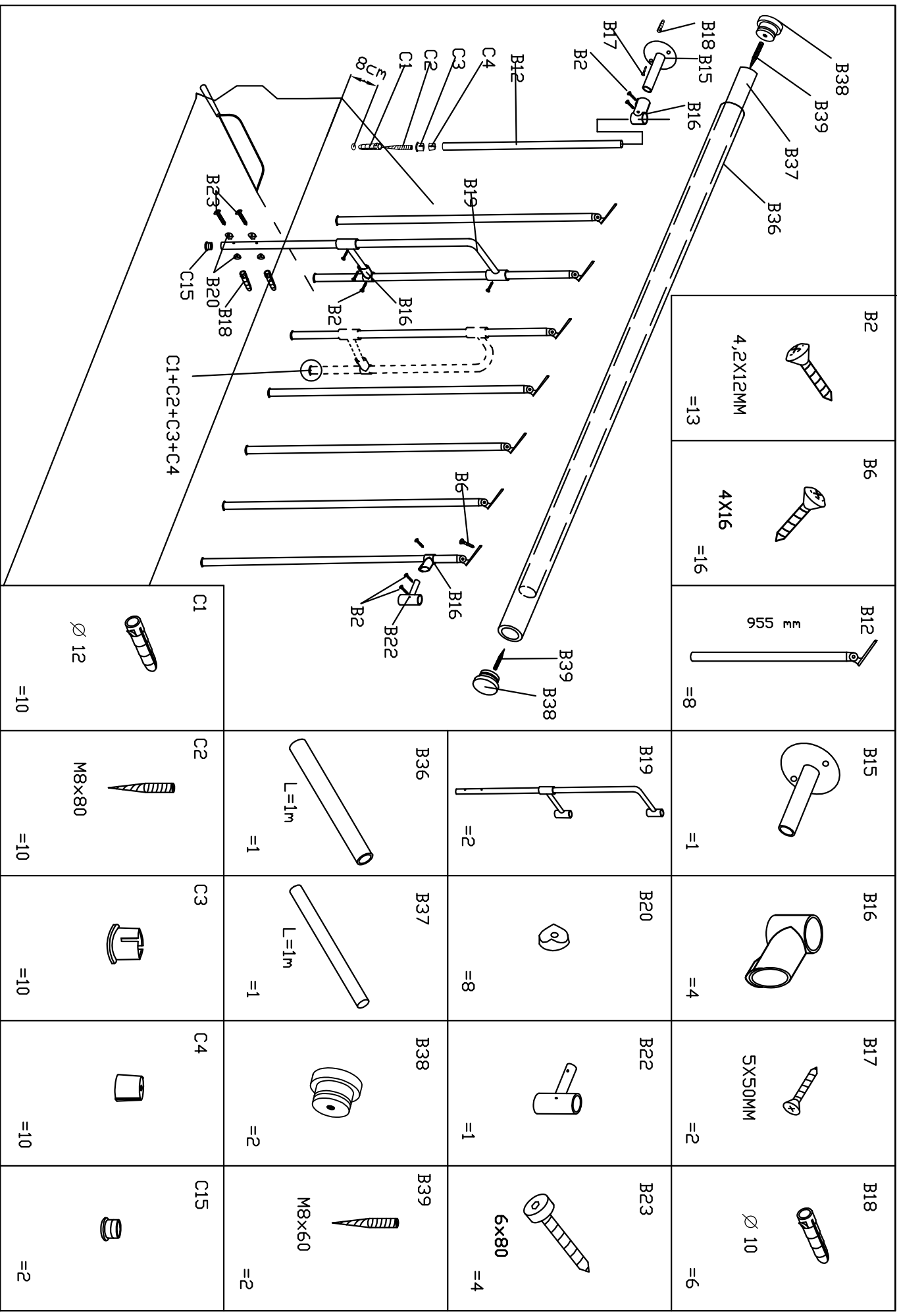



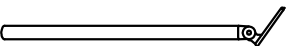



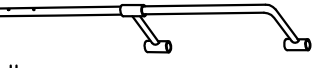

<p>A10</p>  <p>D120 = Ø100 D140 = Ø100 D160 = Ø114</p> <p>=1</p>	<p>A11</p>  <p>D120 = Ø100 D140 = Ø100 D160 = Ø114</p> <p>=6</p>	<p>A17</p>  <p>=2</p>	<p>A20</p>  <p>M12 220mm M12</p> <p>=1</p>	<p>B3</p>  <p>1155 mm</p> <p>=1</p>	<p>B4</p>  <p>1010 mm</p> <p>=1</p>	<p>B6</p>  <p>4X16</p> <p>=2</p>		<p>C7</p>  <p>M6x6 =2 HEX 3=1</p>	<p>C8</p>  <p>=2</p>	<p>C9</p>  <p>=2</p>	<p>C10</p>  <p>=2</p>	<p>C11</p>  <p>=1</p>
<p>D1</p>  <p>=1</p>	<p>C3</p>  <p>=1</p>	<p>C4</p>  <p>=1</p>	<p>C5</p>  <p>8 mm A8x24</p> <p>=1</p>	<p>C6</p>  <p>M8x60mm</p> <p>=1</p>								





BARI - D 120/140/160



B2		4,2X12MM =13
B6		4X16 =16
B12		E 156 =8
B15		=1
B16		=4
B17		5X50MM =2
B18		Ø 10 =6

B19		=2
B20		=8
B22		=1
B23		6X80 =4

B36		L=1m =1
B37		L=1m =1
B38		=2
B39		M8X60 =2

C1		Ø 12 =10
C2		M8X80 =10
C3		=10
C4		=10
C15		=2

BARI

L=100 cm